

# VEICHI

## SI23 Series Solar Pumping Inverter



# VEICHI

Shenzhen Veichi Electric Co., Ltd

Third floor, Building Chunsheng, Lulingya Industrial Park, No.1  
Tangtou community, Shiyan street, Baoan District, Shenzhen  
Tel: +86-0755-3686 1688  
Fax: +86-755-2968 5680 E-mail: overseas@veichi.com

Facebook: <https://www.facebook.com/veichiglobal/>

Suzhou Veichi Electric Co., Ltd

No.1000 Songjia road, Wuzhong Economic and Technological  
Development Zone, Suzhou  
Tel: +86-512-6617 1988  
Fax: +86-512-6617 3610

Whatsapp: +86- 138 2881 8903

[Http://www.veichi.org](http://www.veichi.org)



Wechat Official Account

\*Version 2018 V1.0  
Veichi Electric Co., Ltd all rights reserved,  
subject to change without notice.



## Company Profile

VEICHI Electric Co., Ltd. is a high-tech enterprise that is professionally engaged in the development, manufacturing and marketing of industrial automatic control products, and we are committed to becoming a global leading provider of industrial automatic control products and system solutions.

VEICHI is a competitive company and adopts the dual-base operating mode, which contains the Shenzhen VEICHI and Suzhou VEICHI. Suzhou VEICHI Electric Co., LTD is located in Suzhou Wuzhong Economic and Technological Development Zone, which covers 50 acres. The total construction area is approximately 80 thousand square meters and all properties are privately run. Additionally, VEICHI is always at the forefront of the domestic industrial automation field.

VEICHI has become the flagship company of industrial automation, which owns an innovative R&D team and establishes a good corporation relationship with famous universities and research institutions. Currently, VEICHI owns more than 110 patents of invention, and many of them are in the leading position both at home and abroad, which completely has independent intellectual property rights.

VEICHI produces a variety of core products, including Variable Frequency Drive (VFD), Servo Drive System, Photovoltaic Inverter, PLC, HMI, and Automation Equipment, which are widely used in industries such as oil & gas, chemical, ceramic, crane & construction hoist, lathe, Auto making, metallurgy, electrical cable and wire, plastic, print and package, textile, chemical fiber, metal work and , coalmining and municipal engineering. Suitable solutions and products are always ready to meet the demands and improve comprehensive competitiveness of customers.

"Innovation is the lifeblood of VEICHI", therefore we're committed to becoming one of the leading providers of electric drives, industrial control and green energy products. VEICHI has set up more than 40 brand offices in China and dozens of partners in Asia, Europe and Africa.

VEICHI has been named Chinese Electrical Industry's Top Ten National Brands, Chinese Electrical Industry Top Ten Satisfying Brands and Top Ten National Brands of Inverter Industry. VEICHI products have become the first choice of many enterprises.

**VEICHI** 苏州伟创电气设备技术有限公司  
SUZHOU VEICHI ELECTRIC CO.,LTD.





## SI23 Solar Pump Inverter Pure like water

### Fashion Appearance

#### Simple Layout

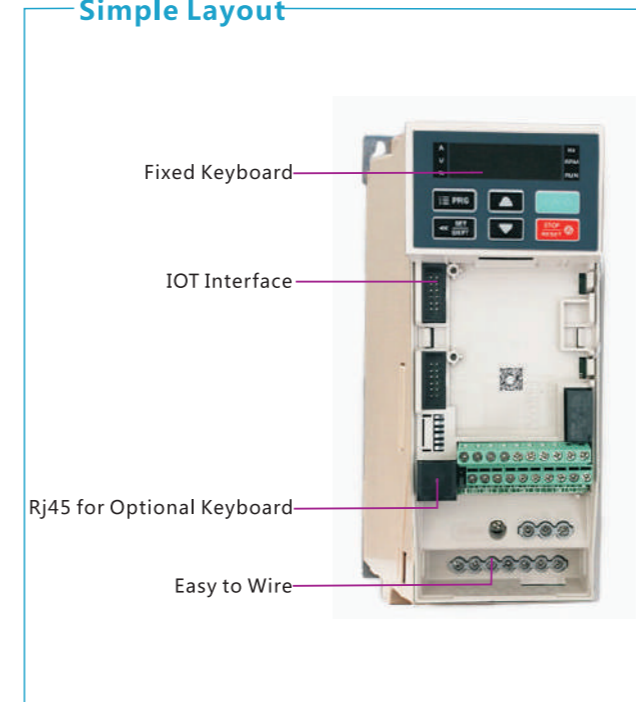

#### Concise Keyboard

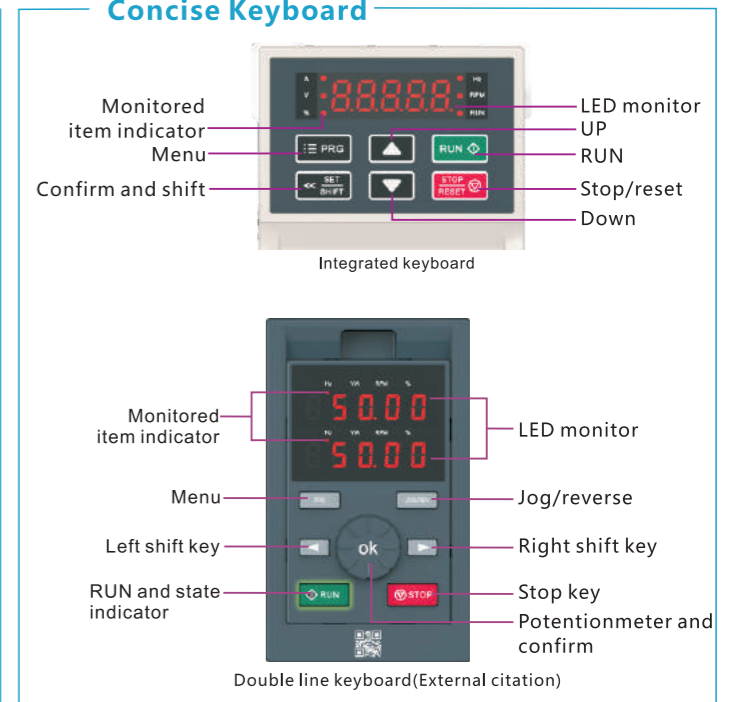

### Narrow body

SI23 series all adopt book narrow-body design, and the volume is 60% smaller than the original, which is the real "book-body machine" of inverter.

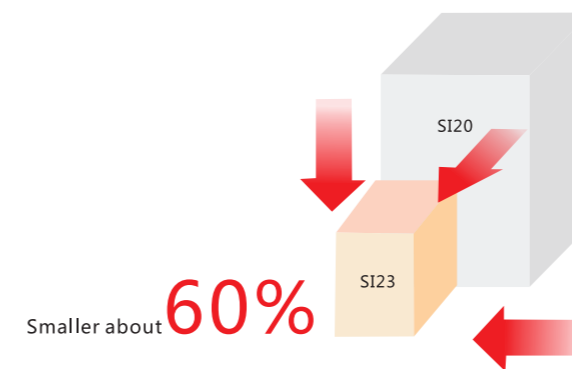

380V 2.2kW demonstration

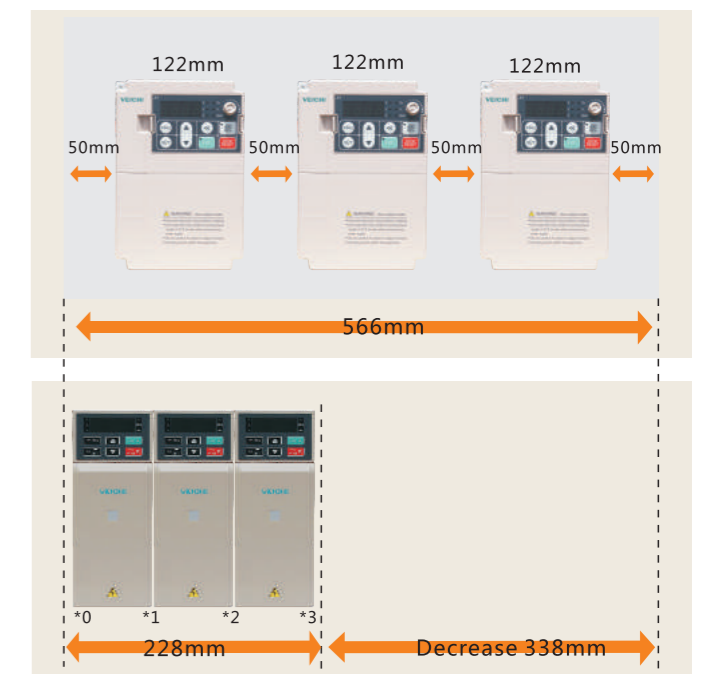

Fashion Appearance

Smart IOT

MPPT Technology

AM/PMSM/  
Single Phase

High performance &  
Multi-functions



## Access to Intelligent Agricultural IOT System

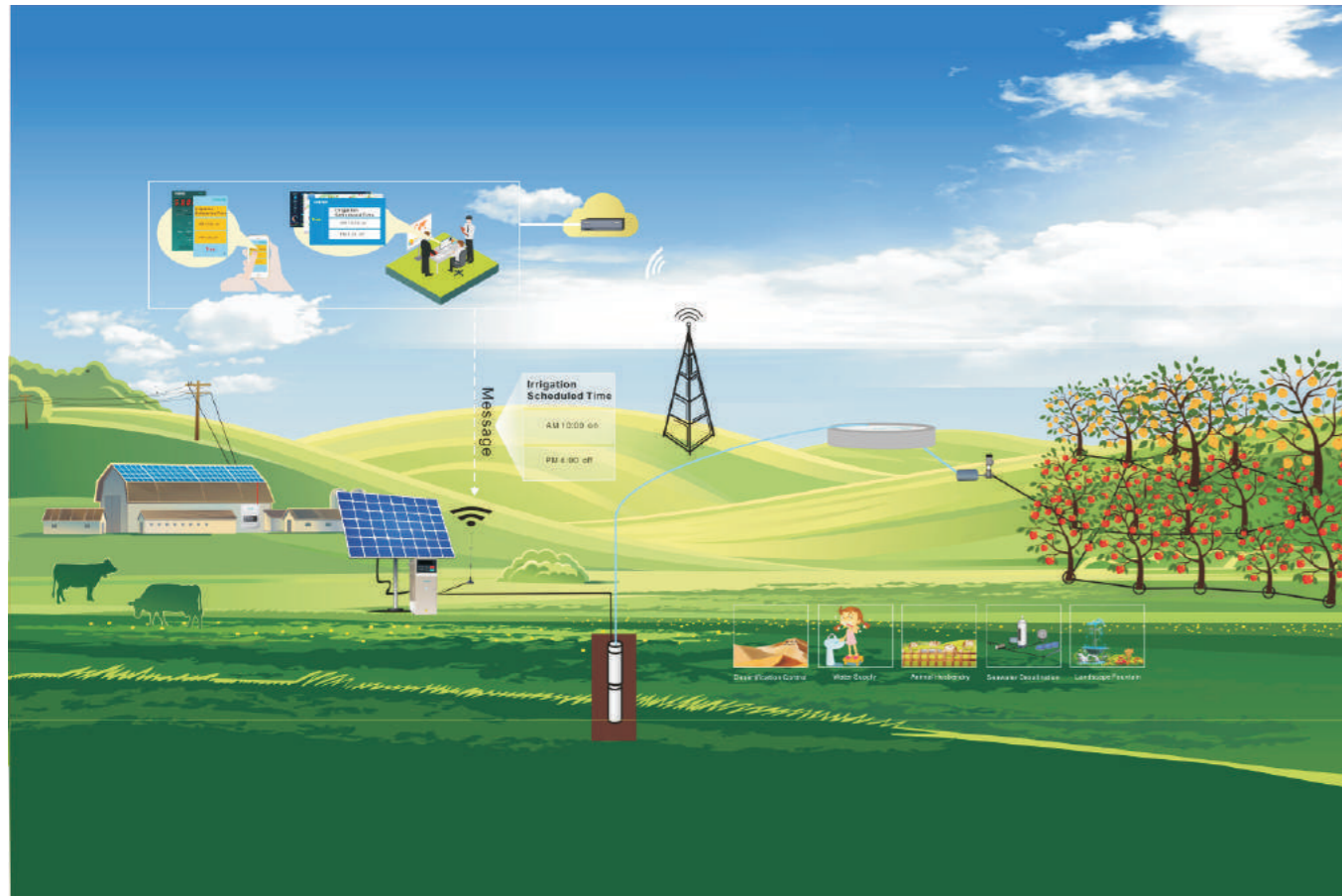

## Smart IOT

**Intelligent monitoring brings smart irrigation**

Custom PQ curve      Intelligent IOT system

Custom PQ curve: automatically calculate the parameters most concerned by users based on the curve, such as flow speed, daily flow, cumulative flow, daily power generation, and cumulative power generation.

Intelligent IOT system: IOT data platform, wireless transmission technology (GPRS, Bluetooth or WIFI), intelligent judgment of needs for water and fertilizer for achieving smart irrigation.

**Remote control of mobile APP can be controlled home**

- Bluetooth, WIFI and GPRS wireless transmission technology.
- Widely-used multi-language switching.
- Drop-down menu for convenient parameter settings.
- Digital display of current data are clear and accurate.
- Ring operation button brings you a special experience.

## Various Types



## Advanced MPPT Technology

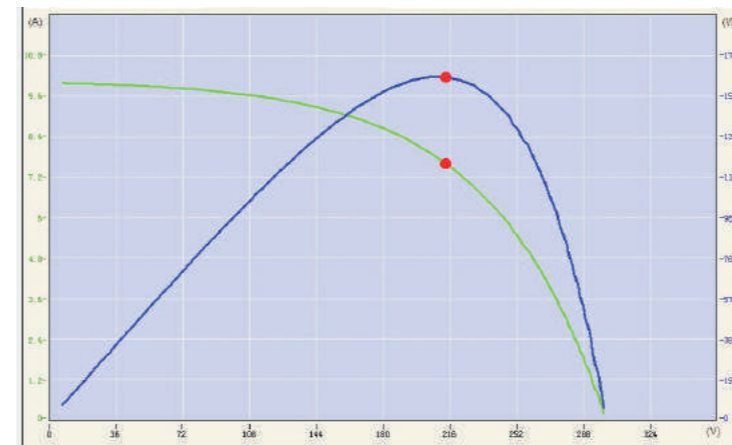

High MPPT Efficiency Max. is 99.9%

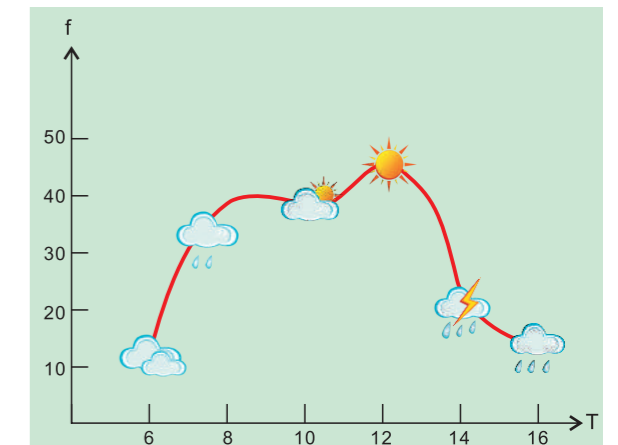

Auto-Track at any daytime

## High Performance & Multi-functions

**High Overload Capacity**

150% rated current 1min  
180% rated current 10s  
200% rated current 0.5s

**Excellent Control Performance**

Open-loop torque response < 20ms,  
steady speed accuracy 0.2%(PMSM),  
0.5%(AM)

**High Frequency**

Max. output frequency is 600Hz  
under VC control



## Default Auto-Running

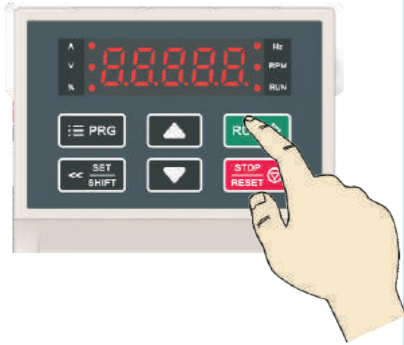

Auto-Running by Keyboard



Scheduled Auto-Running by IOT

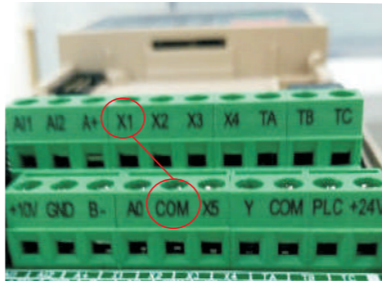

Auto-Running by X1 and COM

## One- Key Operation



Just RUN it for AM pump system;  
Just RUN it after self-tuning for PMSM pump system.

## VCASoft Client

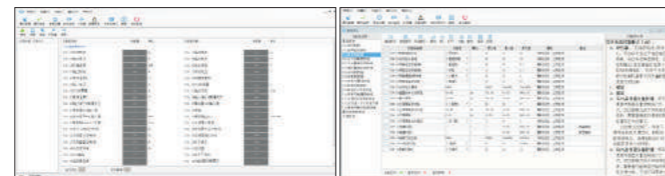

## Special Functions

- ◉ Low frequency
- ◉ Dry run
- ◉ Over current of pump
- ◉ Minimum power
- ◉ PQ curve
- ◉ Dormancy

## Driving Multiple Types of Pumps

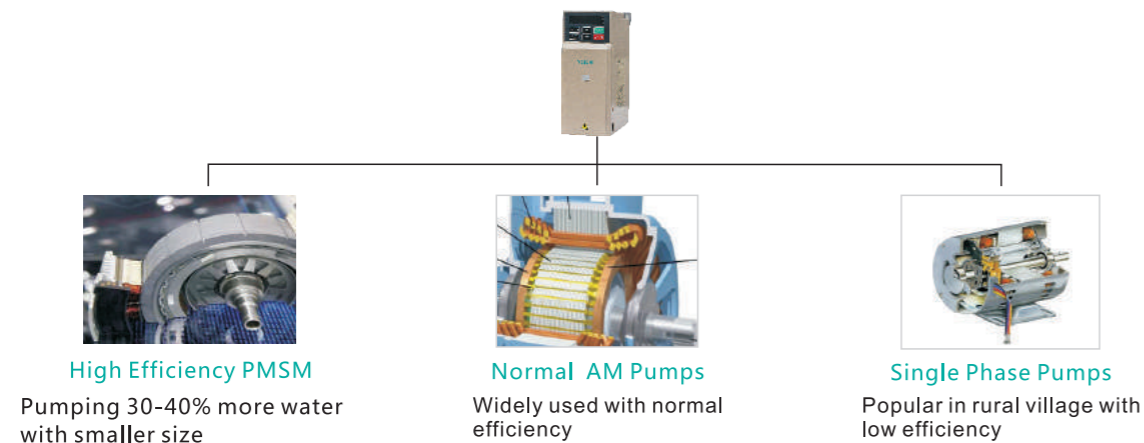

## SI23 Product Model

SI 23 - D5 - 004G

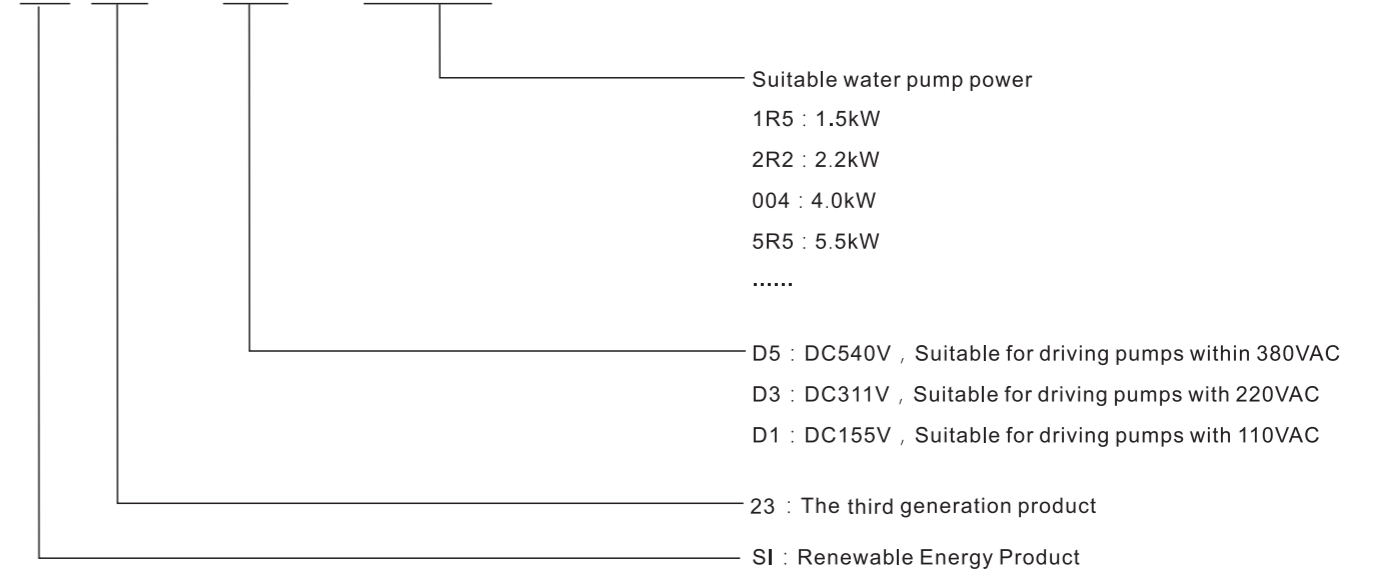

## Solar Pump Drive Model Analysis

Model analysis of three phase AC PMSM Pump Drive				
Product model	Voltage level	Input power		Power range
		DC	AC	
SI23-D1-xxG	110V	60-400VDC	single-phase 110VAC	0.75-1.5kW
SI23-D3-xxG	220V	150-450VDC	single-phase 220VAC	0.75-4kW
SI23-D5-xxG	380V	250-780VDC	three-phase 380VAC	0.75-30kW
SI23-T3-xxG	380V	350-780VDC	three-phase 380VAC	37.0-200kW

## Industry Applications





## Technical Specification

Solar Pump Inverter Power(KW)	Pump		Maximum Input Power of Solar panel(KW)	Maximum Input DC Voltage(V)	Total Voc range (V) of Recommended Panels	Rated Output Current(A)	Output Frequency Range(Hz)
	Rated Power (KW)	Rated Voltage(V)					
SI23-D1 Series: Input 60-400VDC, 3 Phase 110-230VAC Output, Suitable for AC110V Pumps							
0.75	0.75	110	1.0	400	175-380	7A	0-600
1.5	1.5	110	1.95	400	175-380	10A	0-600
SI23-D3 Series: Input 150-450VDC, 3 Phase 150-230VAC Output, Suitable for AC220V Pumps							
0.75	0.75	220	1.0	450	360-430	4A	0-600
1.5	1.5	220	1.95	450	360-430	7A	0-600
2.2	2.2	220	2.86	450	360-430	10A	0-600
4.0	4.0	220	4.81	450	360-430	16A	0-600
SI23-D5 Series: Input 250-780VDC, 3 Phase 230-460VAC Output, Suitable for AC380V Pumps							
0.75	0.75	380	1.0	780	620-750	2.5A	0-600
1.5	1.5	380	2.2	780	620-750	4.0A	0-600
2.2	2.2	380	3.3	780	620-750	6.0A	0-600
4.0	4.0	380	5	780	620-750	10A	0-600
5.5	5.5	380	8	780	620-750	13A	0-600
7.5	7.5	380	10	780	620-750	17A	0-600
11	11	380	14.3	780	620-750	25A	0-600
15	15	380	19.5	780	620-750	32A	0-600
18.5	18.5	380	23.4	780	620-750	38A	0-600
22	22	380	28.6	780	620-750	45A	0-600
30	30	380	39	780	620-750	60A	0-600
SI23-T3 Series: Input 350-780VDC, 3Phase 230-460VAC Output, Suitable for AC380V Pumps							
37	37	380	48.1	780	620-750	75A	0-600
45	45	380	58.5	780	620-750	90A	0-600
55	55	380	71.5	780	620-750	110A	0-600
75	75	380	97.5	780	620-750	150A	0-600
93	93	380	120	780	620-750	180A	0-600
110	110	380	143	780	620-750	210A	0-600
132	132	380	171.6	780	620-750	250A	0-600
160	160	380	208	780	620-750	310A	0-600
185	185	380	240.5	780	620-750	340A	0-600
200	200	380	260	780	620-750	380A	0-600

## Technical Specification

Items		Specification
Input Power Supply	voltage, frequency	D1 Type:90-400VDC/1*110VAC 50/60Hz D3 Type:150-450VDC/1*220VAC 50/60Hz D5:Type:250-750VDC/3*380VAC 50/60Hz T3: Type:350-780VDC/3*380VAC 50/60Hz
	Allowable Fluctuations	Voltage Imbalance Rate: < 3% Frequency Fluctuating: ±5% Distortion Rate: confirm to IEC 61800-2
	VFD Efficiency	≥96%
	Total Voc range (V) of recommended panels	D1Type: 175-360VDC D3Type: 360-430VDC D5Type: 620-750VDC T3Type: 620 -750 VDC
Output	MPPT efficiency	Up to 99.9%
	Output frequency range	0-600Hz
	Overload capacity	150% of rated current for 1 minute; 180% of rated current for 10 seconds; 200% of rated current for 0.5 seconds
Protection function	Solar pump protection function	Dry run, low frequency, low power, dormancy, water full, pump over current protection
	Basic protection function	Bus overvoltage, under voltage, inverter over current, module fault, inverter overload, motor overload, current detection zero drift fault, Hall fault, E2RCM fault, motor grounding short circuit fault, input phase loss, output phase loss, inverter overheat, communication fault, motor parameter self-tuning fault
	Motor grounding short-circuit detection	Automatically detect whether the motor is short-circuit to ground. Auto detection while electrify
	Servo control	Support synchronous and asynchronous servo control, perform pulse tracking, zero servo, indexing positioning and other basic servo functions, and support the orthogonal pulse given
	Communication network	Support 485 / Modbus protocol, CANopen protocol, and profibus-DP protocol; Support Modbus free protocol and CAN customize protocol; can realize the network, linkage control among VEICHI inverters;
	Remote and monitoring functions	Support remote program upgrade, remote monitoring, and remote lock function, can be connected to VEICHI GPRS module; Support VEICHI virtual oscilloscope monitoring and debugging;
Environment	Installation site	Indoor, altitude less than 1000m, free corrosive gases and direct sunlight
	Temperature, humidity	-10~50℃ 20%~95%RH (No condensation)
	Vibration	Less than 0.5g when frequency less than 20Hz
	Storage Temperature	-20~60℃
	Installation mode	Hanging machine, cabinet machine
	Ingress Protection	IP20
Cooling Method	Forced air-cooling	
International Certificate	CE	



## Solar panels recommended configuration

Solar pump inverter model	Solar panel model 1			Solar panel model 2			Solar panel model 3			
	Voc: 21V±2V			Voc: 31V±2V			Voc: 43V±2V			
	P±3W	Isc	configuration	P±3W	Isc	configuration	P±3W	Isc	configuration	Inverter rated current
SI23-D1-R75G										7A
SI23-D1-1R5G										10A
SI23-D3-R75G	30W	2.75A	17*2							4A
SI23-D3-1R5G	60W	3.48A	17*2							7A
SI23-D3-2R2G	90W	5.5A	17*2							10A
SI23-D3-004G	90W	5.5A	17*3							16A
SI23-D5-R75G	30W	2.75A	30*1							2.3A
SI23-D5-1R5G	60W	3.48A	30*1							3.7A
SI23-D5-2R2G	90W	5.5A	30*1							5A
SI23-D5-004G	85W	4.7A	28*2							10A
SI23-D5-5R5G				180W	7.33A	19*2				13A
SI23-D5-7R5G				240W	8.81A	20*2	200W	7.32A	15*3	17A
SI23-D5-011G				180W	7.33A	20*4	240W	7.32A	15*4	25A
SI23-D5-015G				240W	8.81A	20*4	240W	7.32A	15*5	32A
SI23-D5-018G				240W	8.81A	20*5	240W	7.32A	15*6	38A
SI23-D5-022G				240W	8.81A	20*6	270W	7.32A	15*7	45A
SI23-D5-030G				240W	8.81A	20*8	270W	7.32A	15*10	60A
SI23-T3-037G				270W	8.81A	20*9	270W	7.32A	15*11	75A
SI23-T3-045G				270W	8.81A	20*10	270W	7.32A	15*14	90A

**Note:**

The recommended total Vmp of solar panel shall be 1.15 times of inverter bus voltage. For example, in D5 series, the recommended Vmp voltage is 540V\*1.15=621V; and in D3 series, the recommended Vmp voltage is 311\*1.15=357V;

For example, the D1 series recommended Vmp is 155\*1.15=178V.

the recommend total power of solar panel should be at least 1.2 times of the inverter power(drive the same power pump); such as the recommend total power of solar panel for 7.5kW water pump system: 7500\*1.2=9000W;

The maximum withstand voltage of D1 model products is 400VDC; of D3 model products is 450VDC;and of D5 and T3 model products is 780VDC;

## Installation dimension

### Plastic model

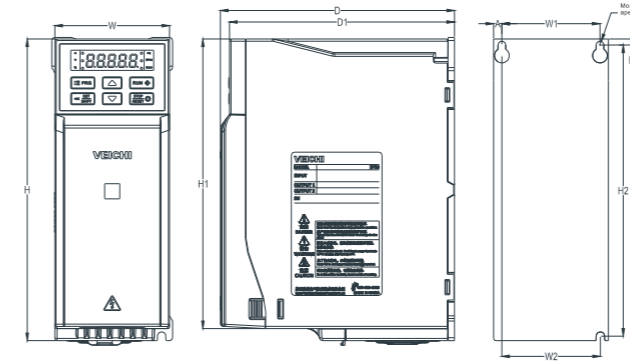

Model	Overall dimension(mm)					Installation dimension (mm)					Installation aperture
	W	H	H1	D	D1	W1	W2	H2	A	B	
SI23-D3-R75G	76	200	192	155	149	65	65	193	5.5	4	3-M4
SI23-D3-1R5G											
SI23-D3-2R2G	100	242	231	155	149	84	86.5	231.5	8	5.5	3-M4
SI23-D3-004G											
SI23-D5-R75G	76	200	192	155	149	65	65	193	5.5	4	3-M4
SI23-D5-1R5G											
SI23-D5-2R2G	100	242	231	155	149	84	86.5	231.5	8	5.5	3-M4
SI23-D5-004G											
SI23-D5-5R5G	116	320	307.5	175	169	98	100	307.5	9	6	3-M5
SI23-D5-7R5G											
SI23-D5-011G											

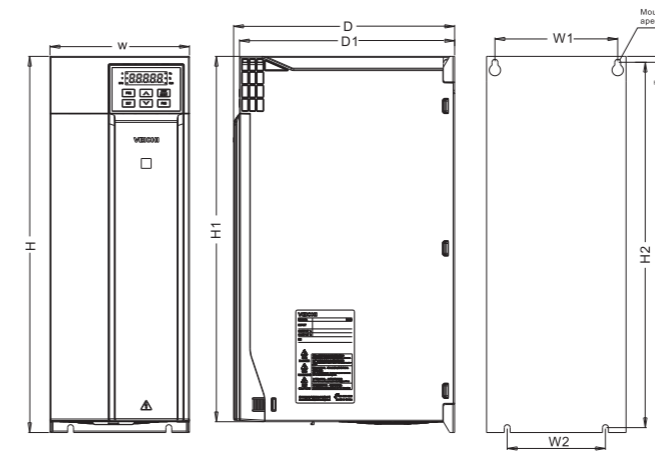

Model	Overall dimension(mm)					Installation dimension (mm)				Installation aperture
	W	H	H1	D	D1	W1	W2	H2	B	
SI23-D5-015G	142	383	372	225	219	125	100	372	6	4-M5
SI23-D5-018G										
SI23-D5-022G	172	430	/	225	219	150	150	416.5	7.5	4-M5
SI23-D5-030G										
SI23-T3-037G										

### Steel model

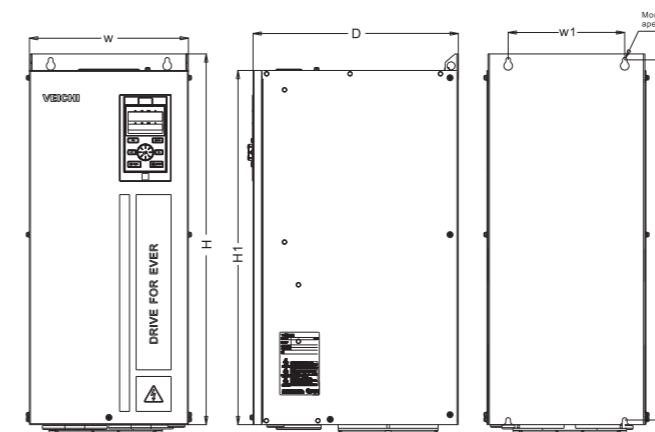

Model	Overall dimension(mm)				Installation dimension(mm)		Installation aperture
	W	H	H1	D	W1	H2	
SI23-T3-045G	240	560	535	310	176	544	4-M6
SI23-T3-055G							
SI23-T3-075G							



## Standard Wiring Diagram

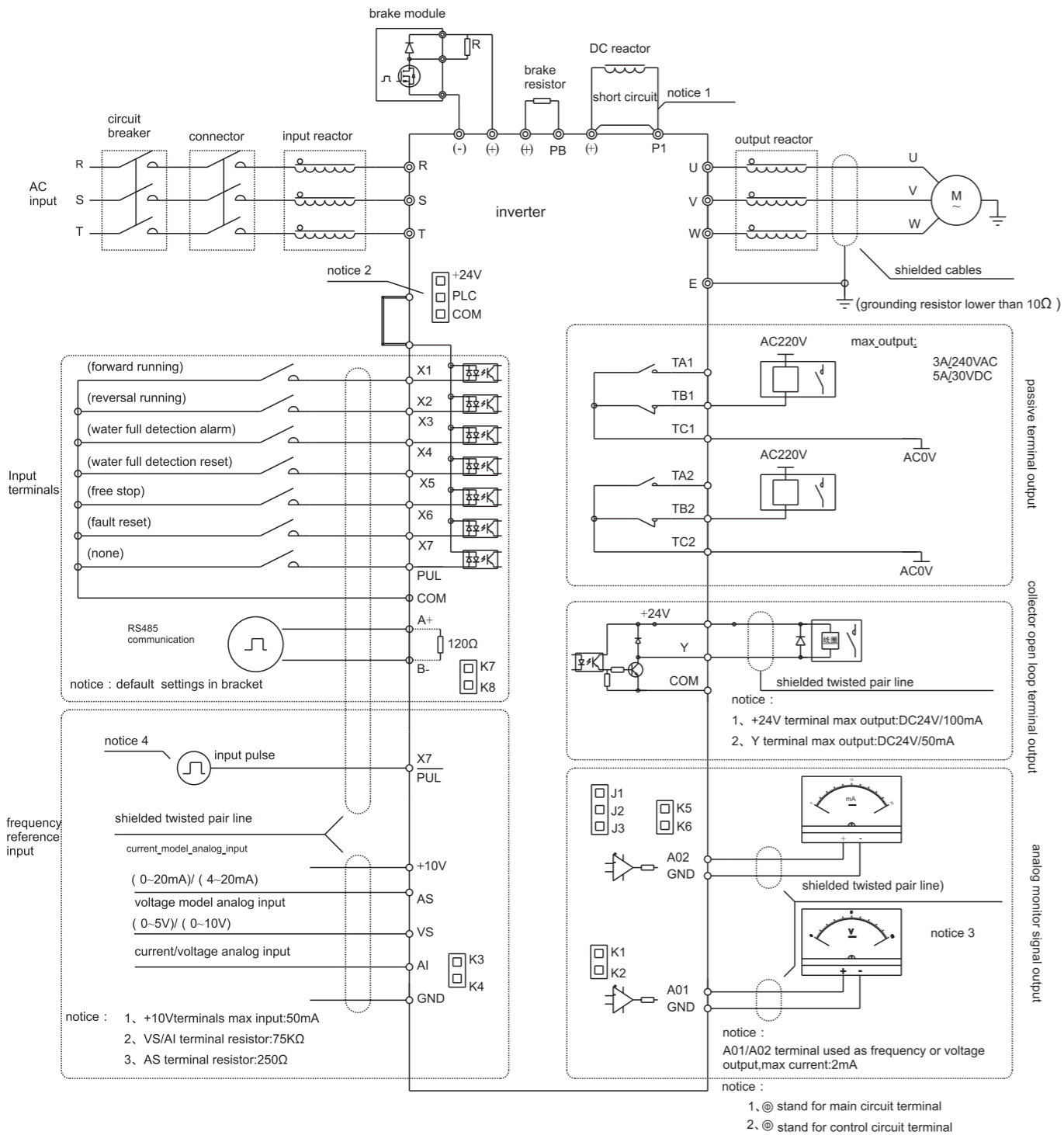

## Domestic marketing services network



Veichi Electric was established in 2005 and headquartered in Shenzhen, China. In October 2013, Suzhou Veichi Electric Co., Ltd. was founded in Suzhou, Jiangsu province which formed two major production bases. Our sales and service network spread all over the country including more than 40 offices and service centers to ensure timely response of customer needs.

## International marketing services network

